

**MN35/22**

**DARWIN**

**21 April 2022**

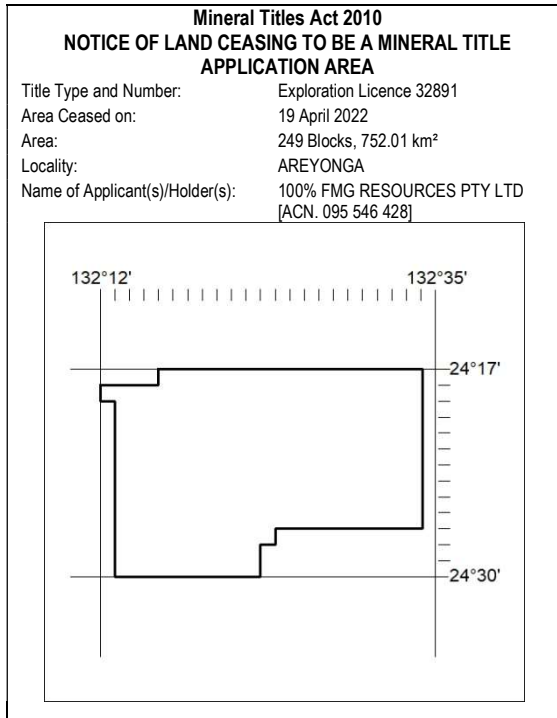

119/22

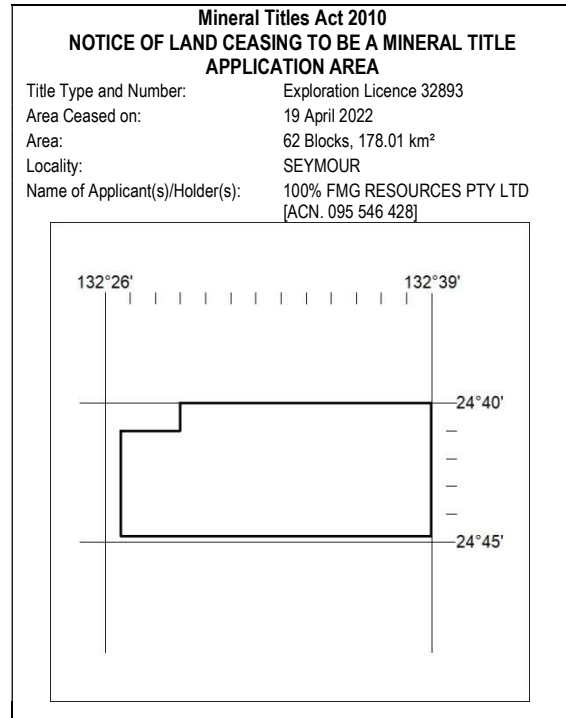

121/22

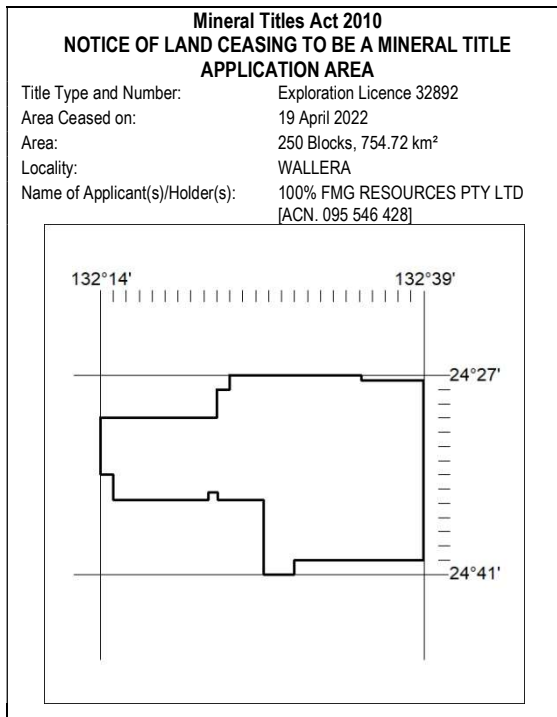

120/22

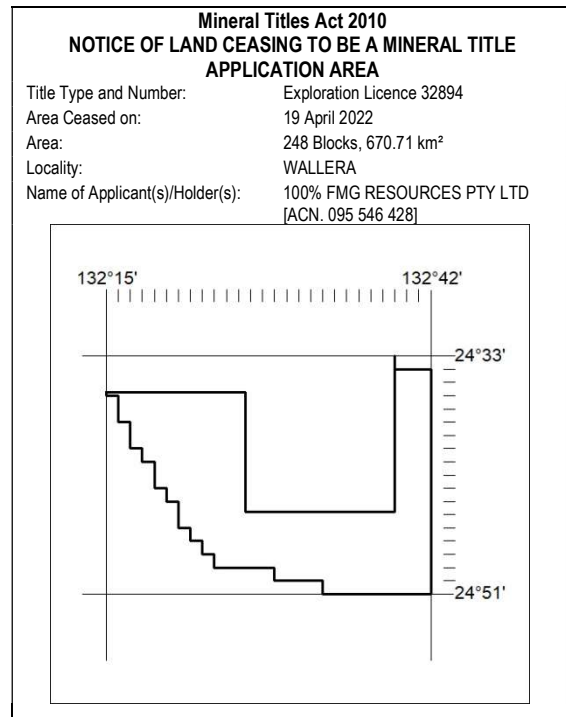

122/22

**MN35/22**

**DARWIN**

**21 April 2022**

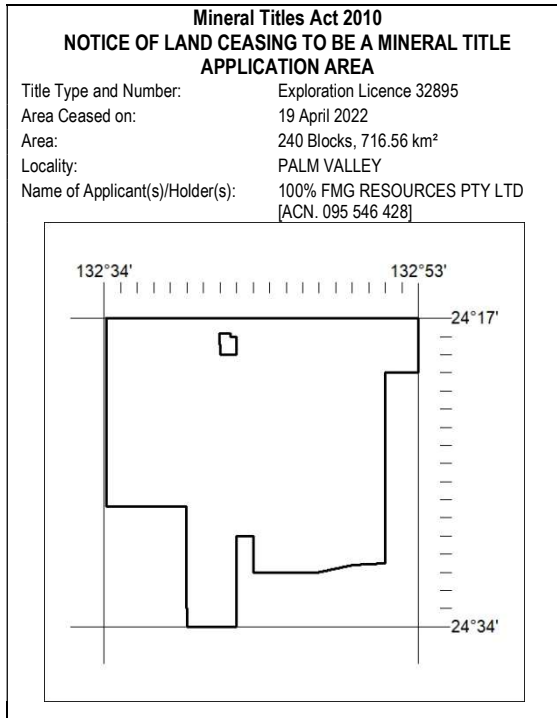

123/22

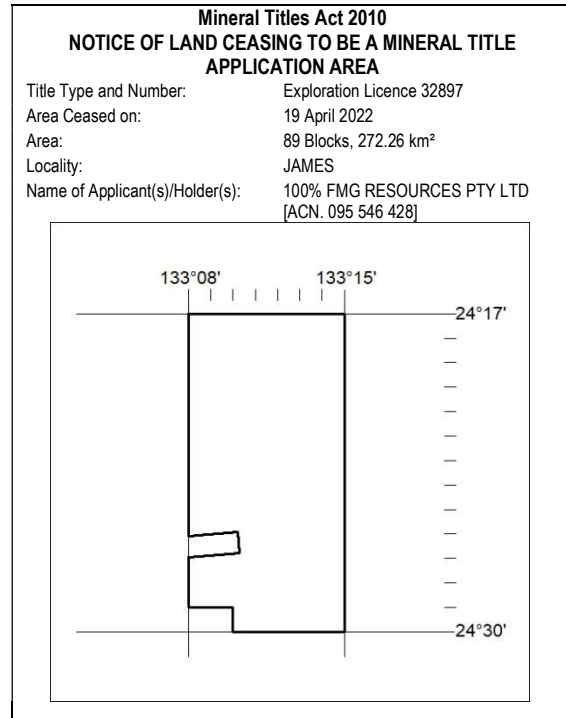

125/22

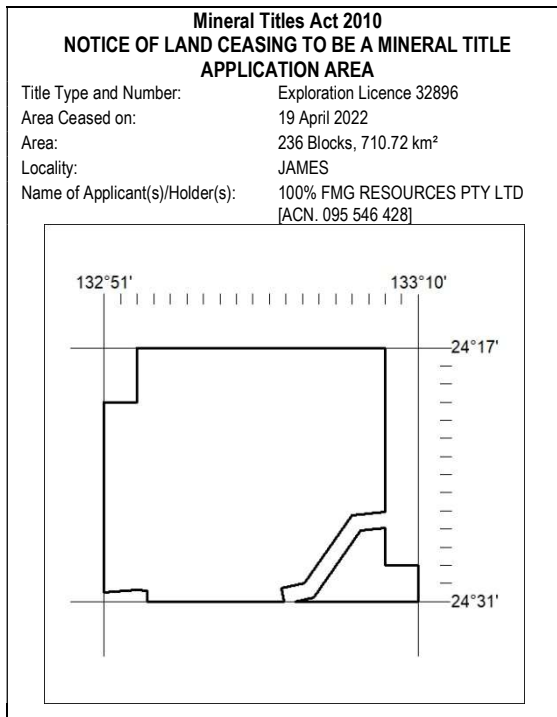

124/22

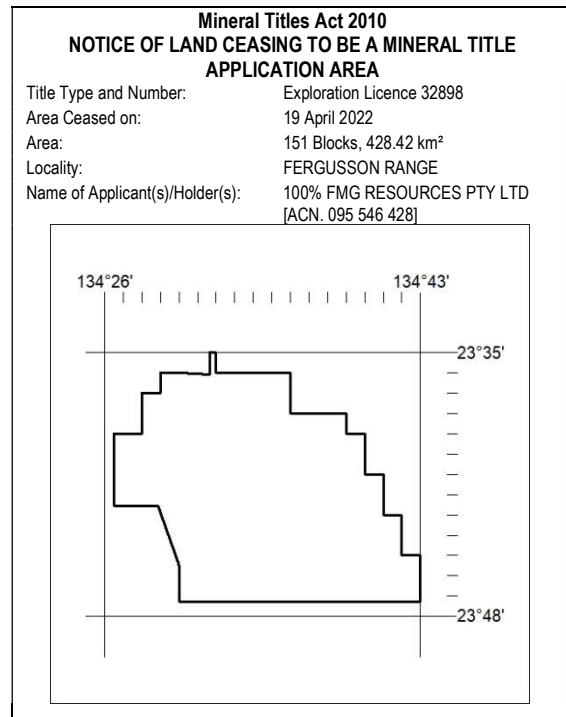

126/22

**MN35/22**

**DARWIN**

**21 April 2022**

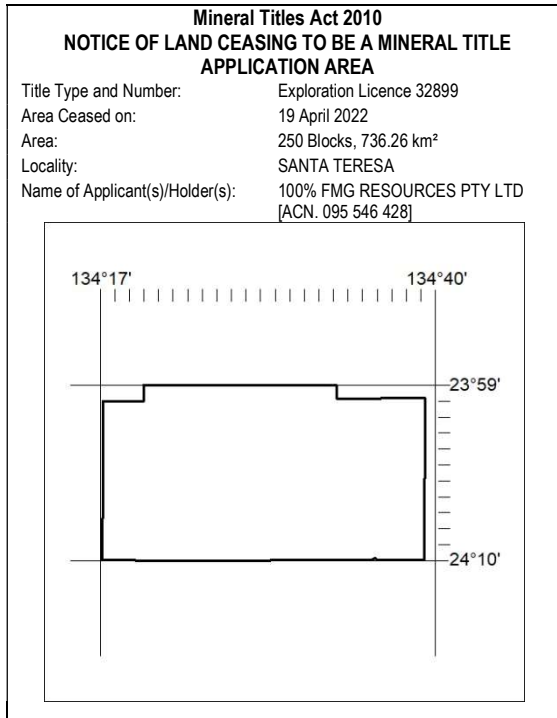

127/22

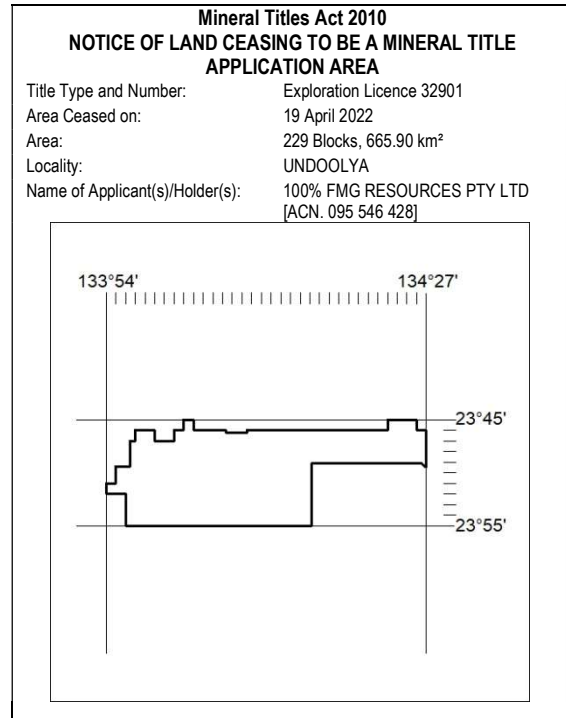

129/22

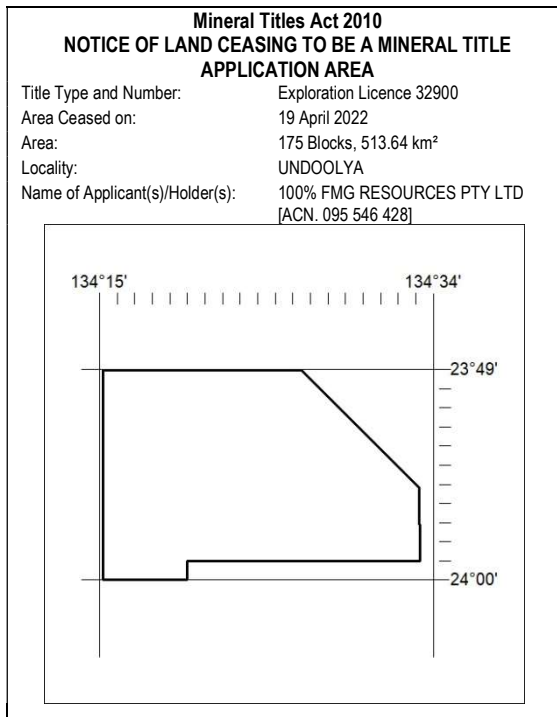

128/22

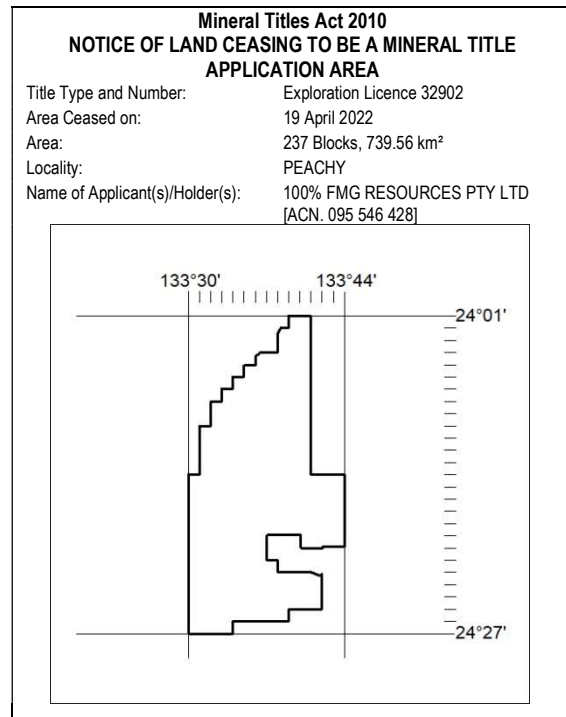

130/22

**MN35/22**

**DARWIN**

**21 April 2022**

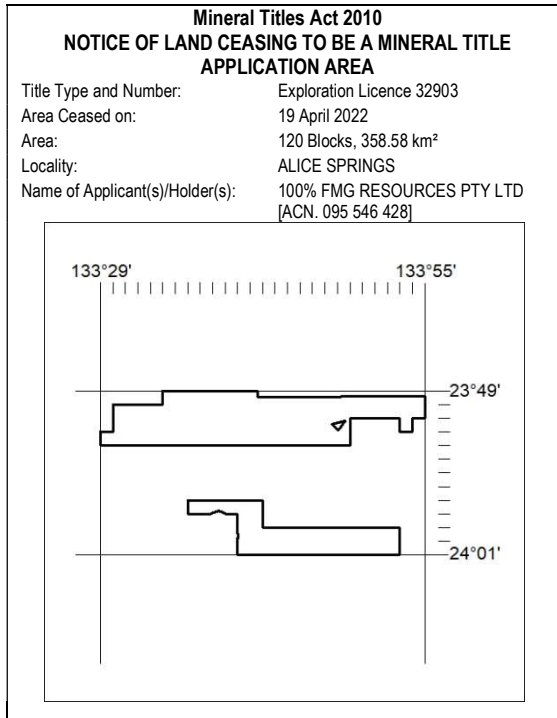

131/22

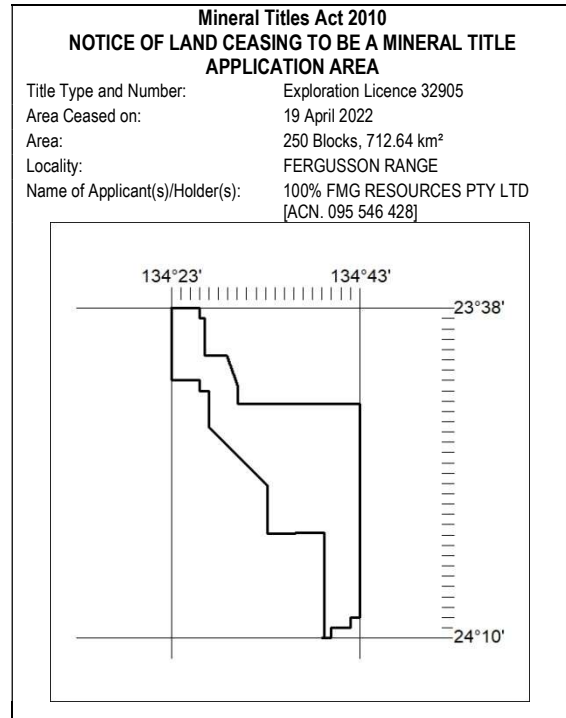

133/22

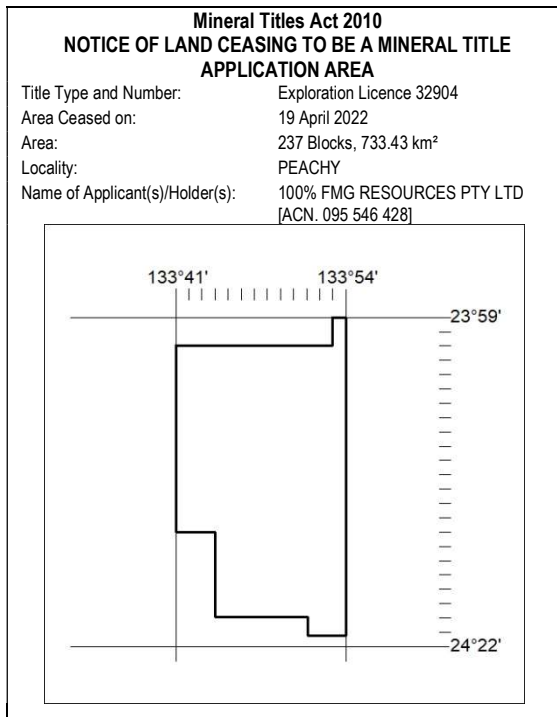

132/22

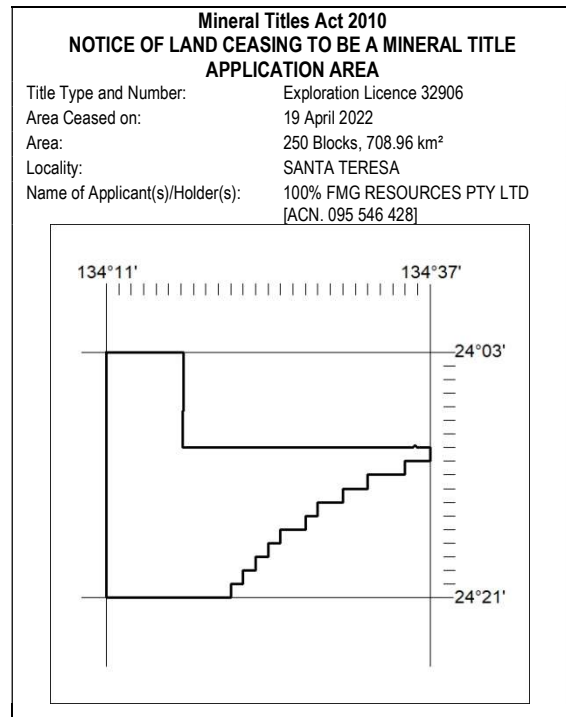

134/22

**MN35/22**

**DARWIN**

**21 April 2022**

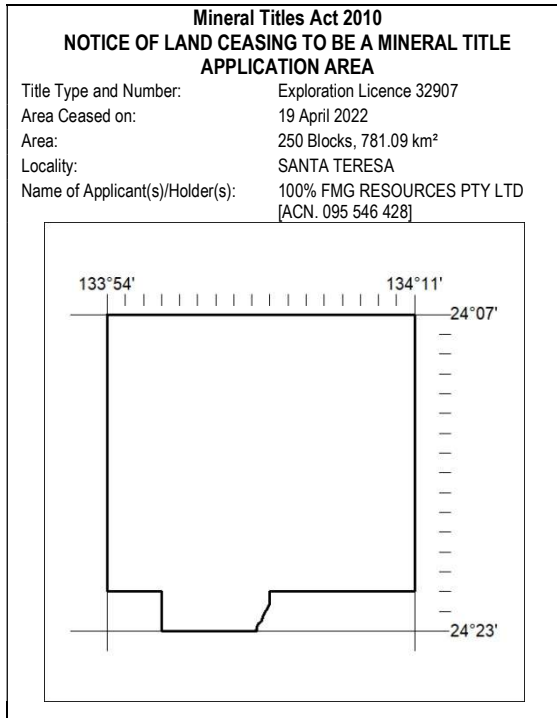

135/22

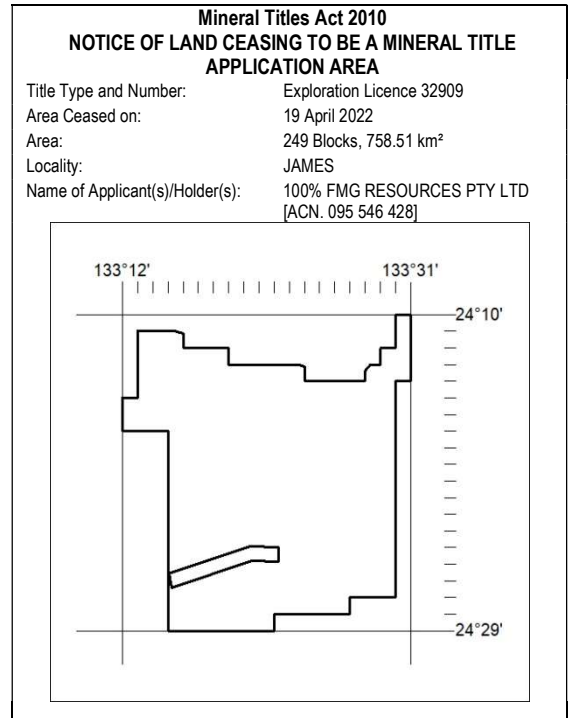

137/22

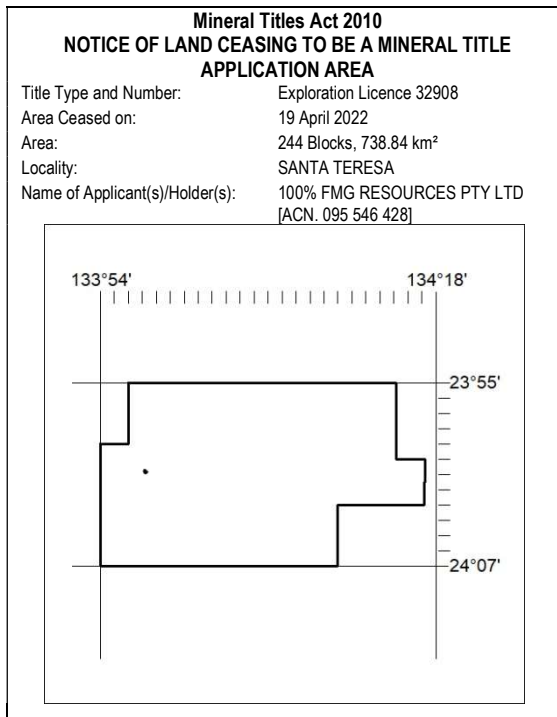

136/22

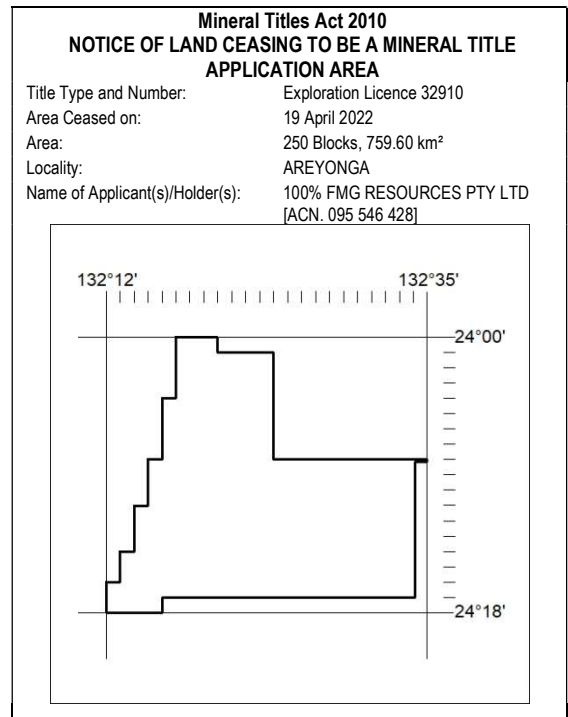

138/22

**MN35/22**

**DARWIN**

**21 April 2022**

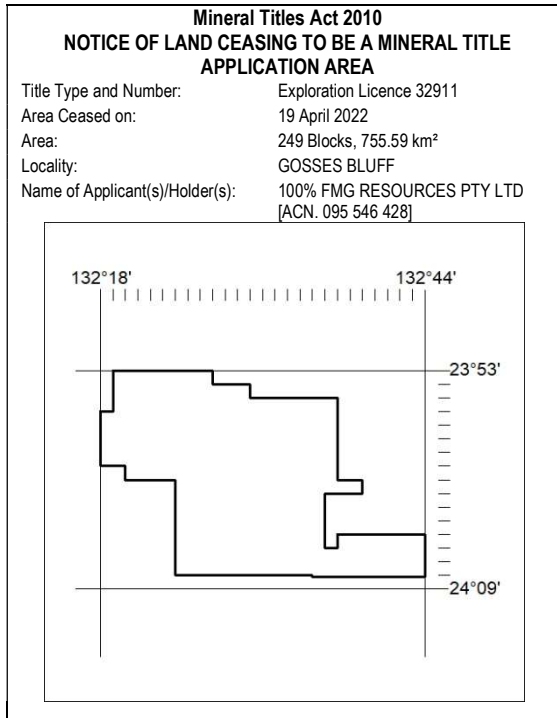

139/22

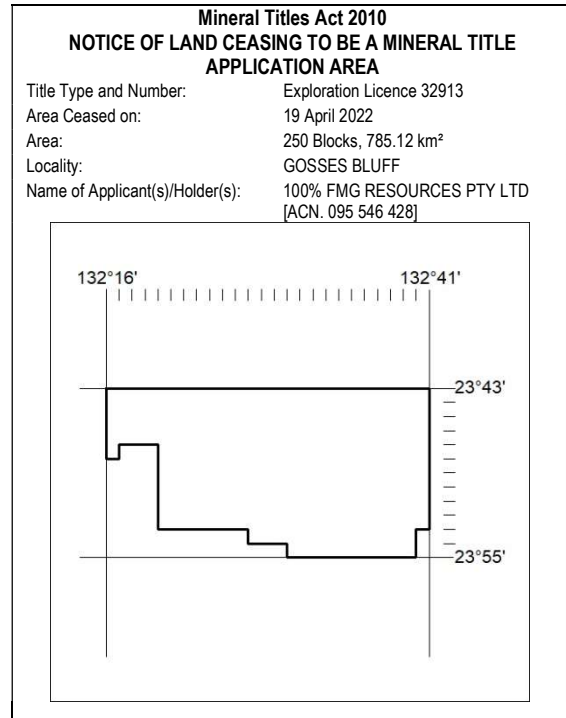

141/22

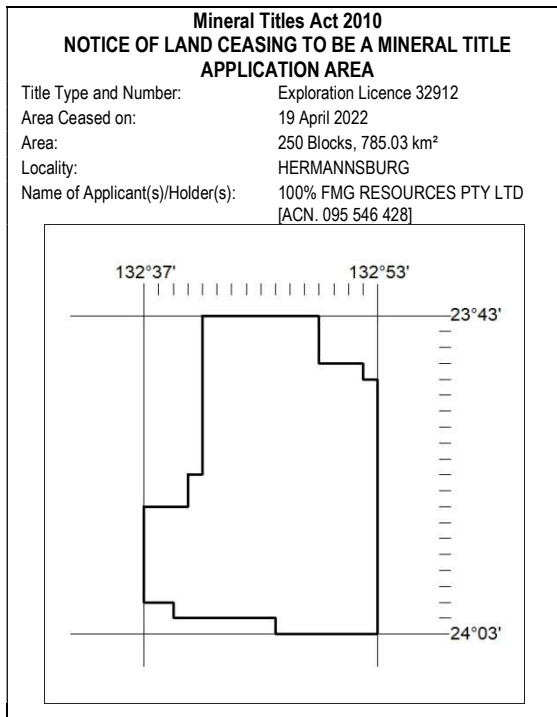

140/22

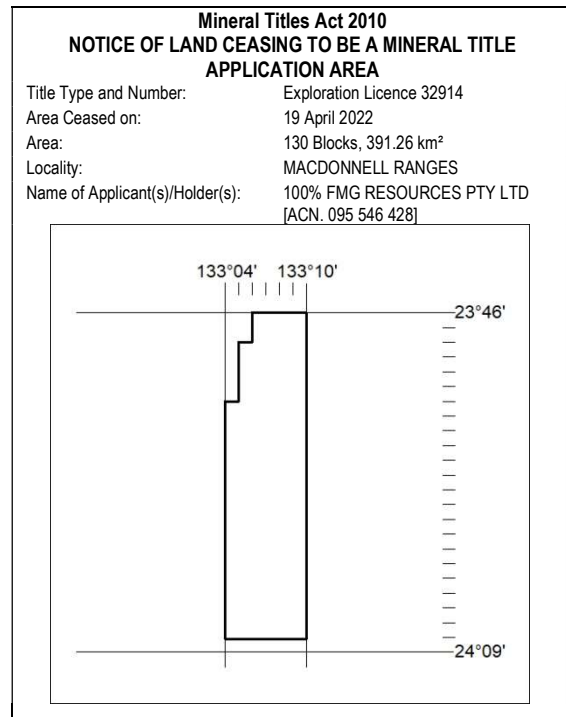

142/22

**MN35/22**

**DARWIN**

**21 April 2022**

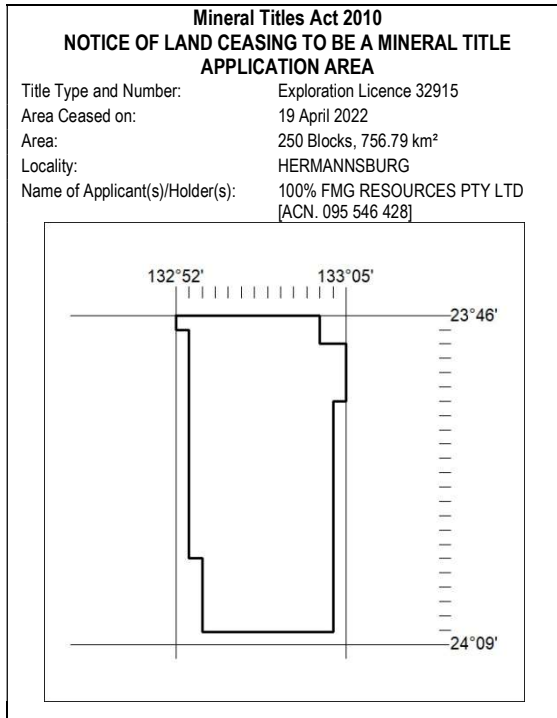

143/22

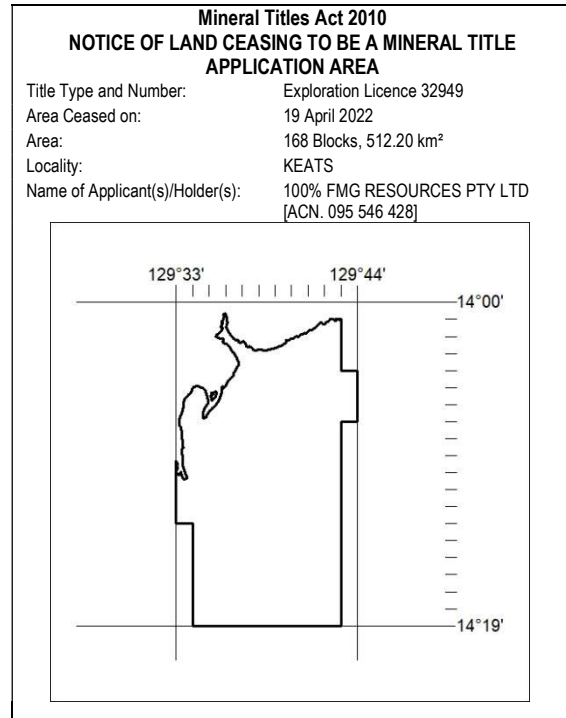

145/22

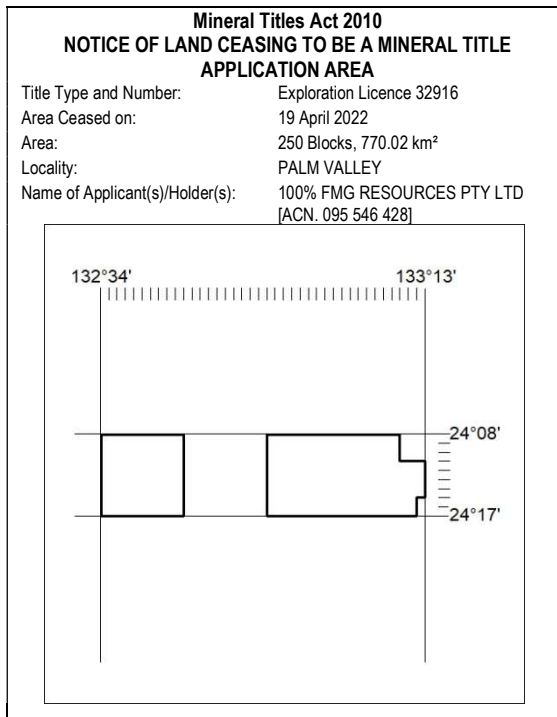

144/22

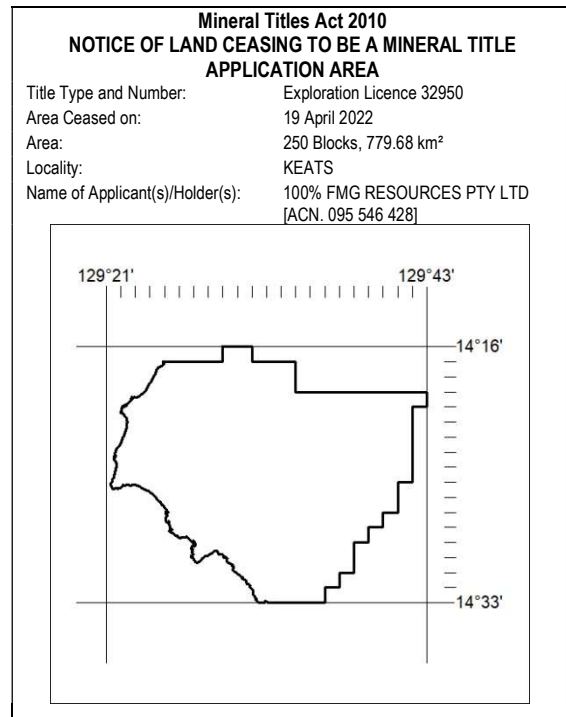

146/22

**MN35/22**

**DARWIN**

**21 April 2022**

**Mineral Titles Act 2010**  
**NOTICE OF LAND CEASING TO BE A MINERAL TITLE**  
**APPLICATION AREA**

Title Type and Number: Exploration Licence 32951  
Area Ceased on: 19 April 2022  
Area: 10 Blocks, 28.26 km<sup>2</sup>  
Locality: PEARCE  
Name of Applicant(s)/Holder(s): 100% FMG RESOURCES PTY LTD  
[ACN. 095 546 428]

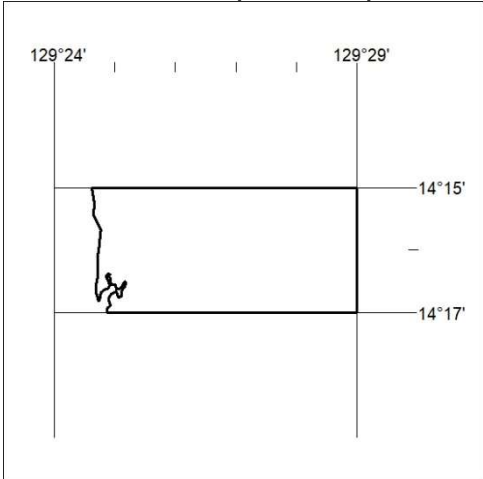

147/22