

**MN96/22**

**DARWIN**

**4 October 2021**

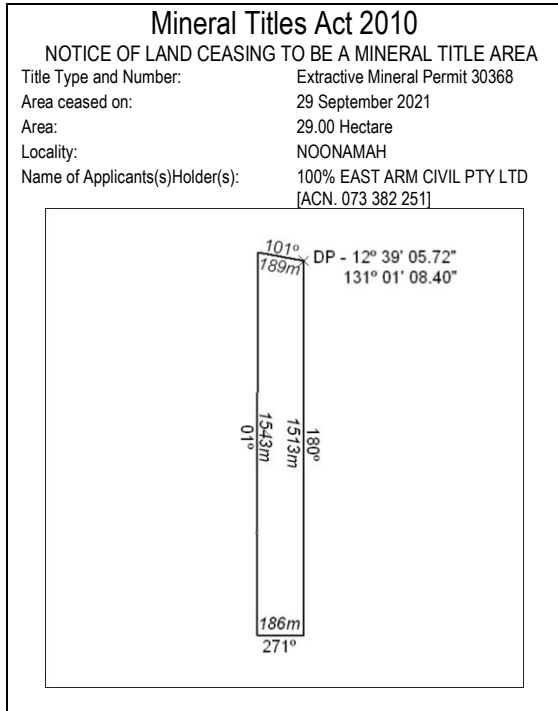

**363/21**

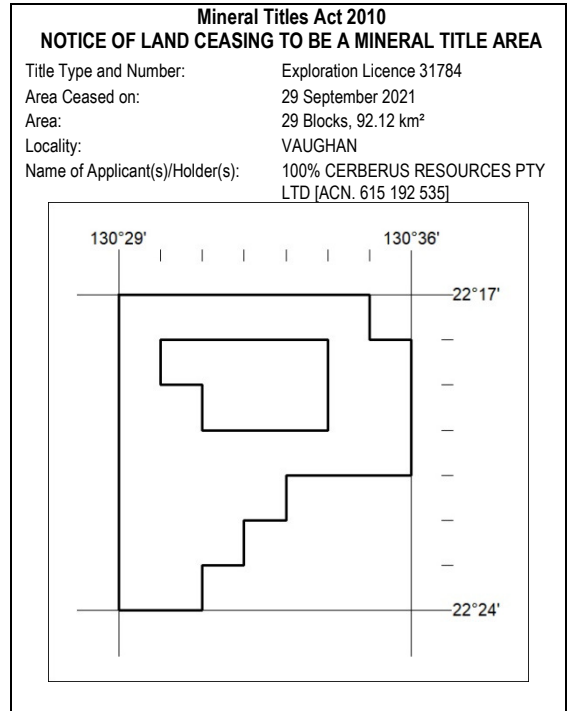

**365/21**

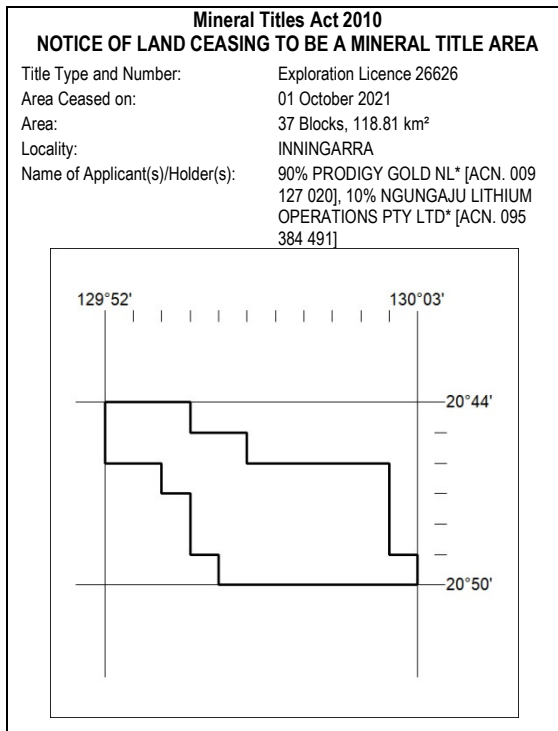

**364/21**

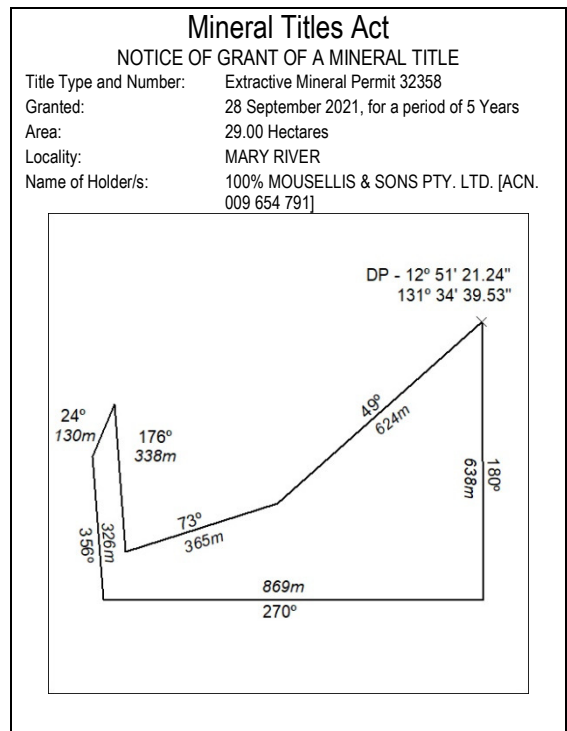

**366/21**

**MN96/22**

**DARWIN**

**4 October 2021**

**Mineral Titles Act**  
NOTICE OF GRANT OF A MINERAL TITLE

Title Type and Number: Exploration Licence 32680  
Granted: 04 October 2021, for a period of 6 Years  
Area: 250 Blocks, 809.04 km<sup>2</sup>  
Locality: RANKEN  
Name of Holder/s: 100% BARKLY OPERATIONS PTY LTD [ACN. 641 856 706]

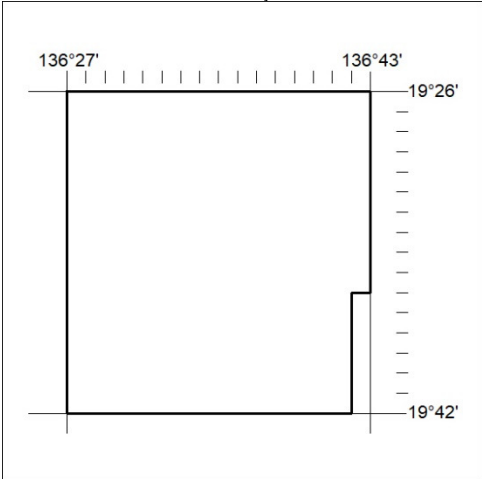

Area granted is indicated above. The titleholder is not permitted to exercise occupational rights on any land that is subject to a development title, or an application for a development title. Any land the subject of a Reserved Land gazettal under the *Mineral Titles Act* and all land vested in the Commonwealth of Australia is also excluded by description but not excised from the grant area.

**367/21**

**Mineral Titles Act**  
NOTICE OF GRANT OF A MINERAL TITLE

Title Type and Number: Exploration Licence 32664  
Granted: 29 September 2021, for a period of 6 Years  
Area: 38 Blocks, 117.73 km<sup>2</sup>  
Locality: RIDDOCH  
Name of Holder/s: 100% BATH RESOURCES PTY LTD [ACN. 643 937 713]

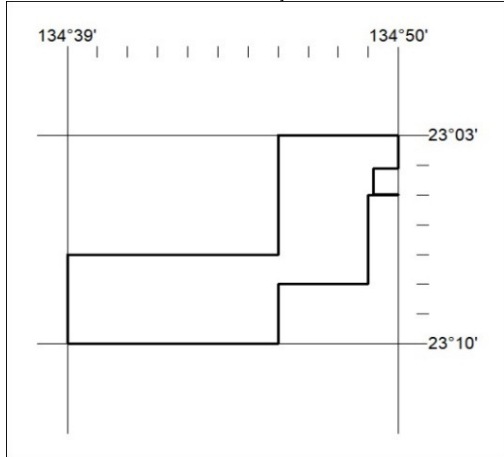

Area granted is indicated above. The titleholder is not permitted to exercise occupational rights on any land that is subject to a development title, or an application for a development title. Any land the subject of a Reserved Land gazettal under the *Mineral Titles Act* and all land vested in the Commonwealth of Australia is also excluded by description but not excised from the grant area.

**369/21**

**Mineral Titles Act**  
NOTICE OF GRANT OF A MINERAL TITLE

Title Type and Number: Extractive Mineral Permit 32702  
Granted: 24 September 2021, for a period of 5 Years  
Area: 95.40 Hectares  
Locality: KATHERINE  
Name of Holder/s: 100% NT LAND DEVELOPMENT CORPORATION PTY LTD [ACN. 078 816 814]

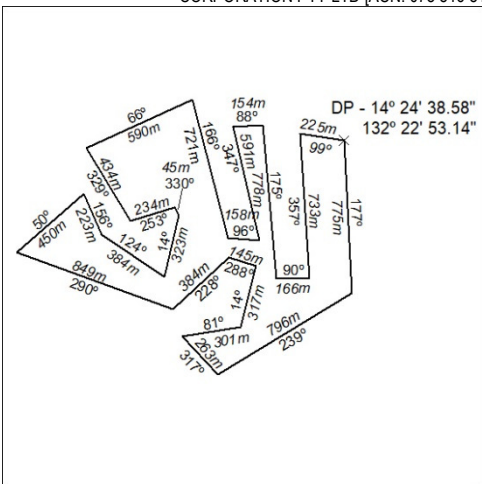

**368/21**

**Corrigendum**

Notice Number 362/21 appearing in MN95/21 on 24 September 2021 is hereby cancelled and replaced by the following:

**Mineral Titles Act 2010**  
NOTICE OF LAND CEASING TO BE A MINERAL TITLE AREA

Title Type and Number: Exploration Licence 29803  
Area Ceased on: 23 September 2021  
Area: 22 Blocks, 71.96 km<sup>2</sup>  
Locality: NAPIER  
Name of Applicant(s)/Holder(s): 100% MARTIN Anthony Ernest

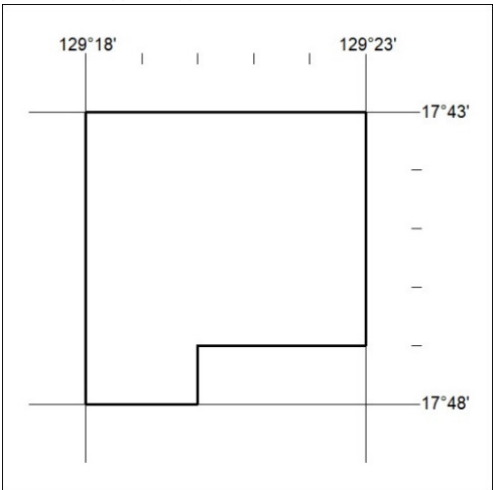

**370/21**