

MN49/21

DARWIN

24 May 2021

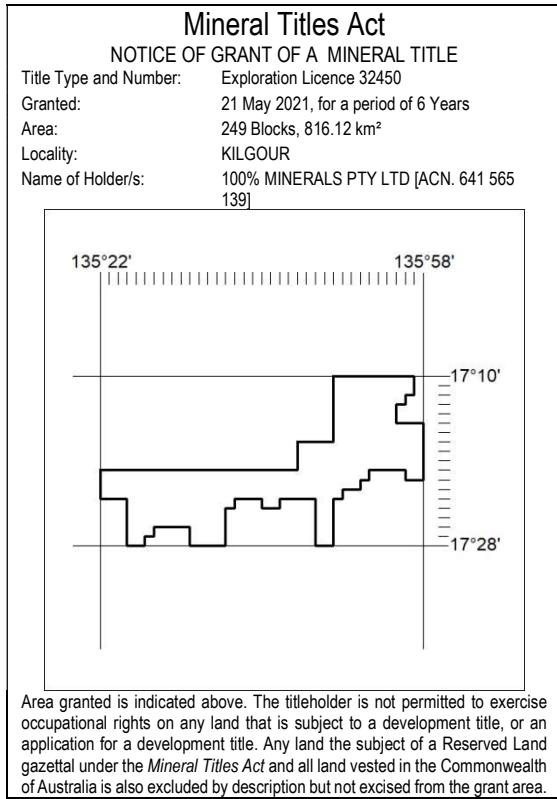

171/21

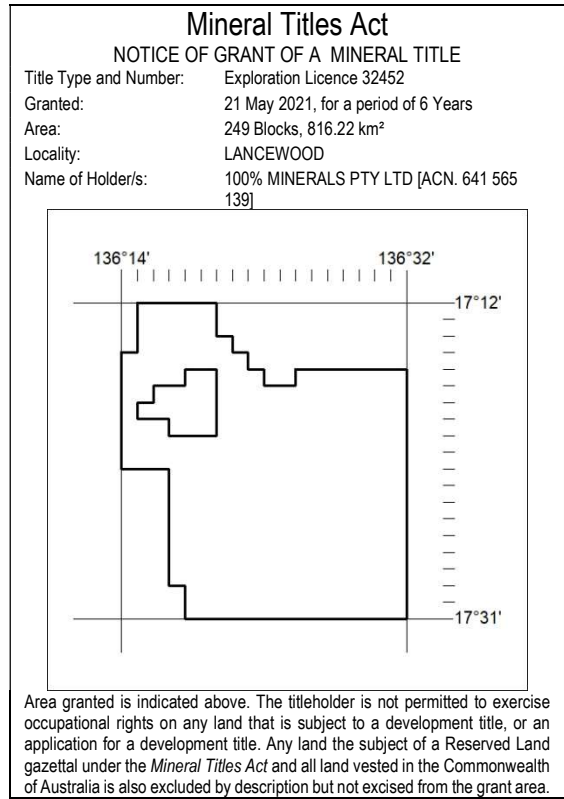

173/21

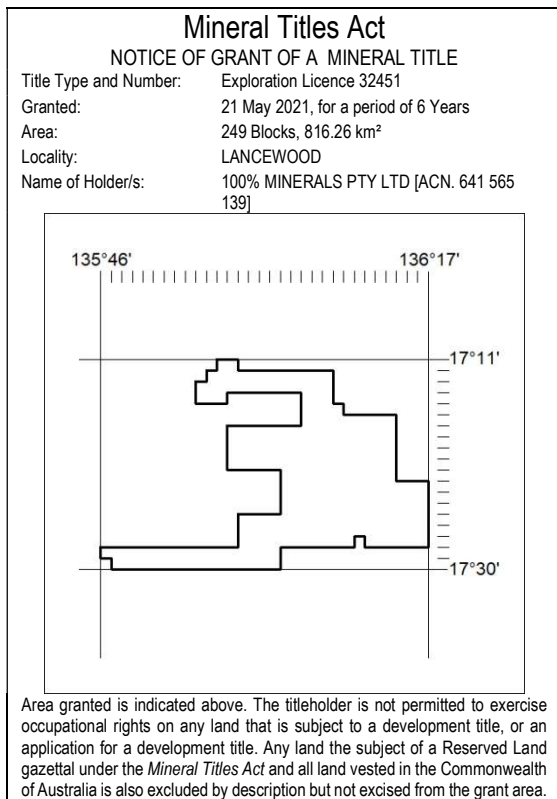

172/21

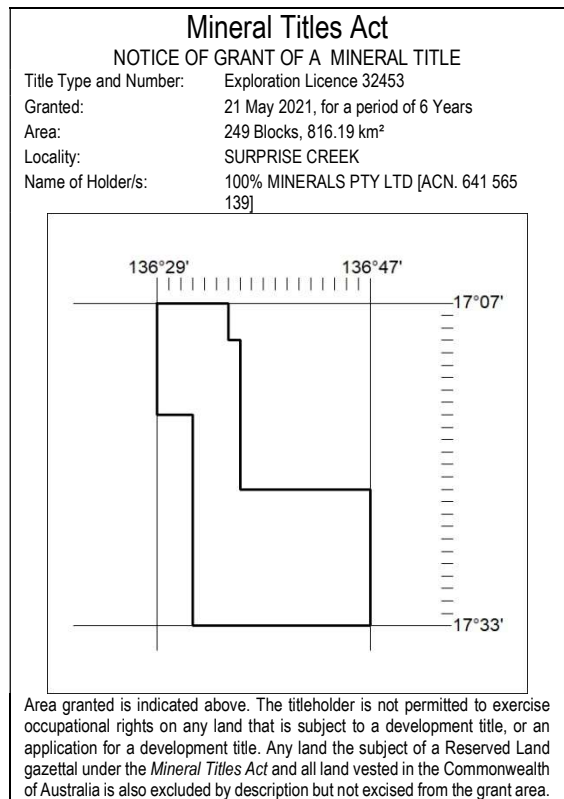

174/21

MN49/21

DARWIN

24 May 2021

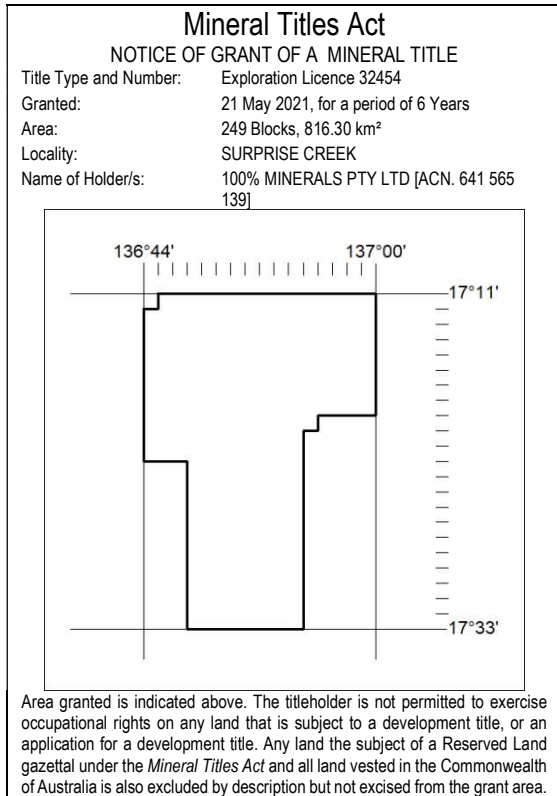

175/21

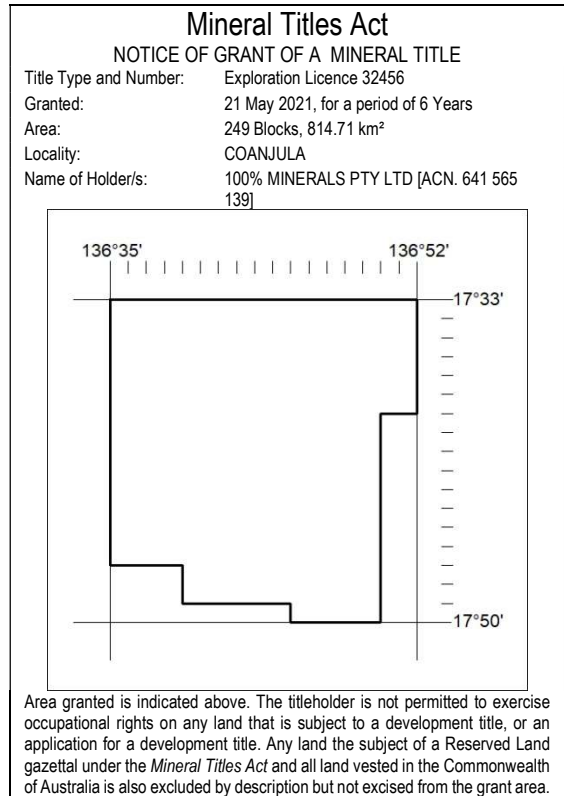

177/21

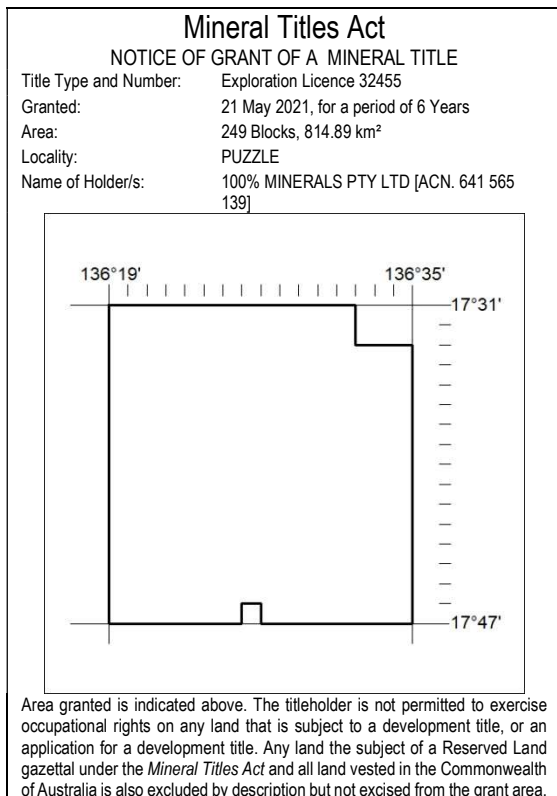

176/21

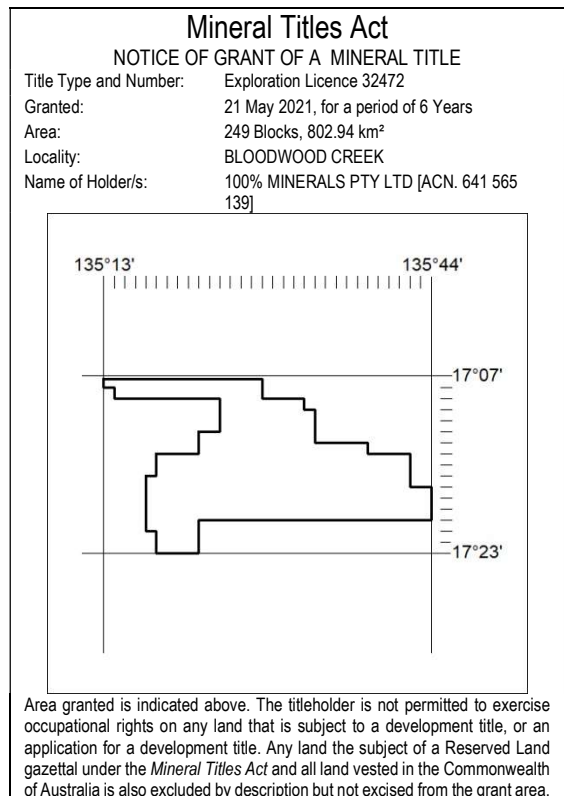

178/21

MN49/21

DARWIN

24 May 2021

Mineral Titles Act
NOTICE OF GRANT OF A MINERAL TITLE

Title Type and Number: Exploration Licence 32473
Granted: 21 May 2021, for a period of 6 Years
Area: 249 Blocks, 815.68 km²
Locality: CALVERT HILLS
Name of Holder/s: 100% MINERALS PTY LTD [ACN. 641 565 139]

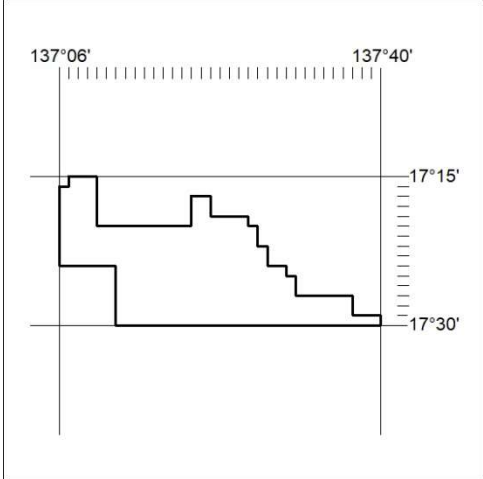

Area granted is indicated above. The titleholder is not permitted to exercise occupational rights on any land that is subject to a development title, or an application for a development title. Any land the subject of a Reserved Land gazettal under the *Mineral Titles Act* and all land vested in the Commonwealth of Australia is also excluded by description but not excised from the grant area.

179/21

Mineral Titles Act
NOTICE OF GRANT OF A MINERAL TITLE

Title Type and Number: Exploration Licence 32474
Granted: 21 May 2021, for a period of 6 Years
Area: 249 Blocks, 795.01 km²
Locality: CALVERT HILLS
Name of Holder/s: 100% MINERALS PTY LTD [ACN. 641 565 139]

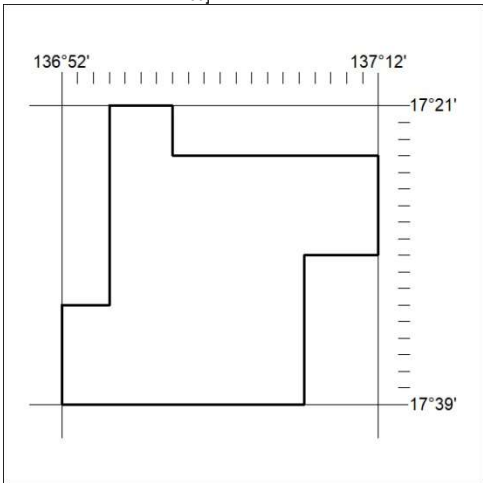

Area granted is indicated above. The titleholder is not permitted to exercise occupational rights on any land that is subject to a development title, or an application for a development title. Any land the subject of a Reserved Land gazettal under the *Mineral Titles Act* and all land vested in the Commonwealth of Australia is also excluded by description but not excised from the grant area.

180/21