

MN30/22

DARWIN

6 April 2022

Mineral Titles Act
NOTICE OF GRANT OF A MINERAL TITLE

Title Type and Number: Exploration Licence 32834
Granted: 05 April 2022, for a period of 6 Years
Area: 191 Blocks, 609.29 km²
Locality: HOME OF BULLION
Name of Holder/s: 100% PEGMATITE ONE PTY LTD [ACN. 652 853 391]

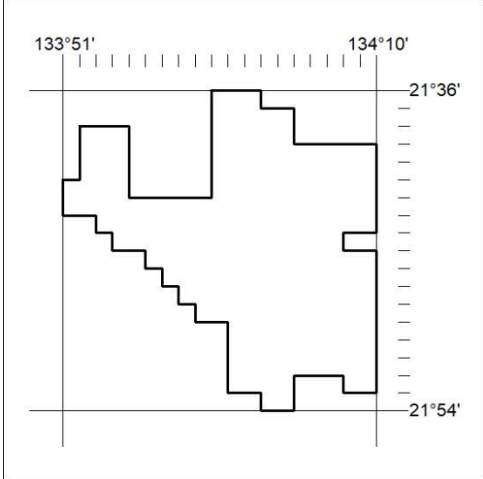

Area granted is indicated above. The titleholder is not permitted to exercise occupational rights on any land that is subject to a development title, or an application for a development title. Any land the subject of a Reserved Land gazettal under the *Mineral Titles Act* and all land vested in the Commonwealth of Australia is also excluded by description but not excised from the grant area.

89/22

Mineral Titles Act
NOTICE OF GRANT OF A MINERAL TITLE

Title Type and Number: Exploration Licence 32839
Granted: 06 April 2022, for a period of 6 Years
Area: 10 Blocks, 32.58 km²
Locality: HELEN
Name of Holder/s: 100% SCRIVEN EXPLORATION PTY LTD [ACN. 006 264 615]

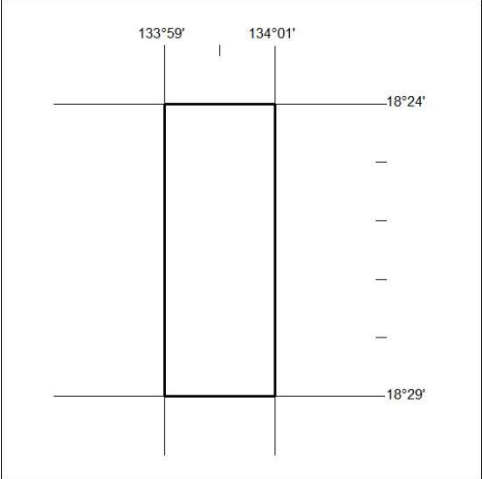

Area granted is indicated above. The titleholder is not permitted to exercise occupational rights on any land that is subject to a development title, or an application for a development title. Any land the subject of a Reserved Land gazettal under the *Mineral Titles Act* and all land vested in the Commonwealth of Australia is also excluded by description but not excised from the grant area.

91/22

Mineral Titles Act
NOTICE OF GRANT OF A MINERAL TITLE

Title Type and Number: Exploration Licence 32835
Granted: 05 April 2022, for a period of 6 Years
Area: 122 Blocks, 389.09 km²
Locality: HOME OF BULLION
Name of Holder/s: 100% PEGMATITE ONE PTY LTD [ACN. 652 853 391]

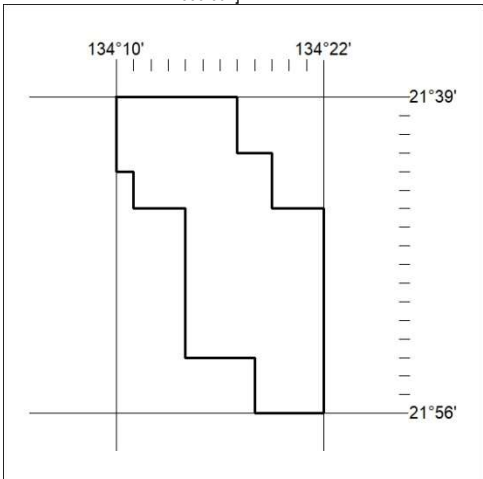

Area granted is indicated above. The titleholder is not permitted to exercise occupational rights on any land that is subject to a development title, or an application for a development title. Any land the subject of a Reserved Land gazettal under the *Mineral Titles Act* and all land vested in the Commonwealth of Australia is also excluded by description but not excised from the grant area.

90/22

Mineral Titles Act
NOTICE OF GRANT OF A MINERAL TITLE

Title Type and Number: Exploration Licence 32840
Granted: 05 April 2022, for a period of 6 Years
Area: 33 Blocks, 105.47 km²
Locality: CONICAL HILL
Name of Holder/s: 100% PEGMATITE ONE PTY LTD [ACN. 652 853 391]

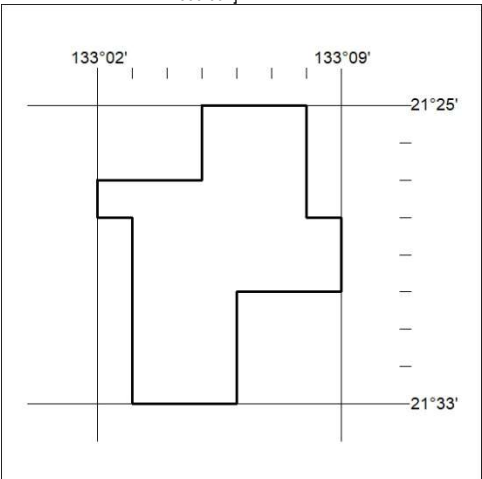

Area granted is indicated above. The titleholder is not permitted to exercise occupational rights on any land that is subject to a development title, or an application for a development title. Any land the subject of a Reserved Land gazettal under the *Mineral Titles Act* and all land vested in the Commonwealth of Australia is also excluded by description but not excised from the grant area.

92/22

MN30/22

DARWIN

6 April 2022

Mineral Titles Act
NOTICE OF GRANT OF A MINERAL TITLE

Title Type and Number: Exploration Licence 32844
Granted: 05 April 2022, for a period of 6 Years
Area: 226 Blocks, 716.38 km²
Locality: REYNOLDS RANGE
Name of Holder/s: 100% PEGMATITE ONE PTY LTD [ACN. 652 853 391]

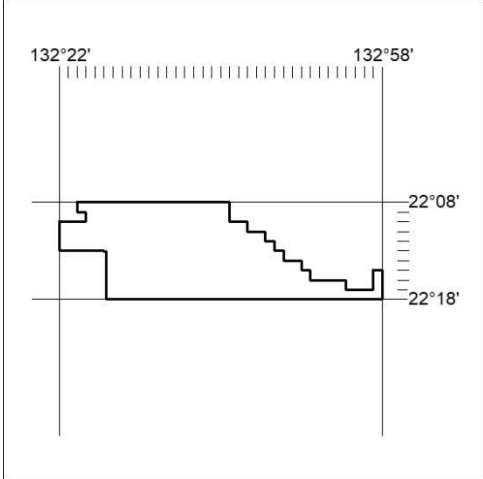

Area granted is indicated above. The titleholder is not permitted to exercise occupational rights on any land that is subject to a development title, or an application for a development title. Any land the subject of a Reserved Land gazettal under the *Mineral Titles Act* and all land vested in the Commonwealth of Australia is also excluded by description but not excised from the grant area.

93/22

Mineral Titles Act
NOTICE OF GRANT OF A MINERAL TITLE

Title Type and Number: Exploration Licence 32846
Granted: 05 April 2022, for a period of 6 Years
Area: 146 Blocks, 462.92 km²
Locality: REYNOLDS RANGE
Name of Holder/s: 100% PEGMATITE ONE PTY LTD [ACN. 652 853 391]

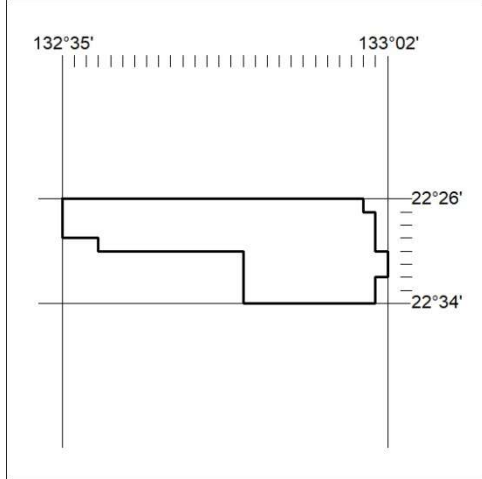

Area granted is indicated above. The titleholder is not permitted to exercise occupational rights on any land that is subject to a development title, or an application for a development title. Any land the subject of a Reserved Land gazettal under the *Mineral Titles Act* and all land vested in the Commonwealth of Australia is also excluded by description but not excised from the grant area.

95/22

Mineral Titles Act
NOTICE OF GRANT OF A MINERAL TITLE

Title Type and Number: Exploration Licence 32845
Granted: 05 April 2022, for a period of 6 Years
Area: 250 Blocks, 789.39 km²
Locality: REYNOLDS RANGE
Name of Holder/s: 100% PEGMATITE ONE PTY LTD [ACN. 652 853 391]

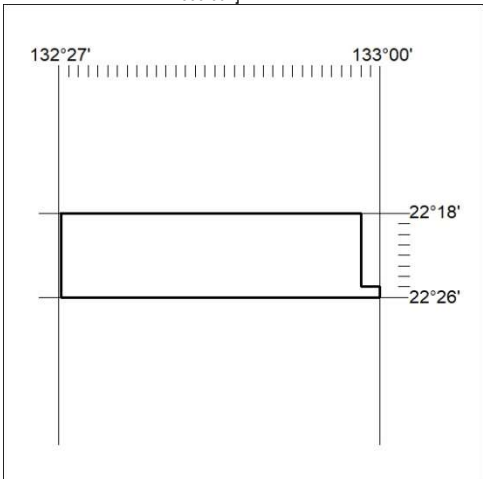

Area granted is indicated above. The titleholder is not permitted to exercise occupational rights on any land that is subject to a development title, or an application for a development title. Any land the subject of a Reserved Land gazettal under the *Mineral Titles Act* and all land vested in the Commonwealth of Australia is also excluded by description but not excised from the grant area.

94/22

Mineral Titles Act
NOTICE OF GRANT OF A MINERAL TITLE

Title Type and Number: Exploration Licence 32847
Granted: 05 April 2022, for a period of 6 Years
Area: 22 Blocks, 70.38 km²
Locality: TAYLOR
Name of Holder/s: 100% PEGMATITE ONE PTY LTD [ACN. 652 853 391]

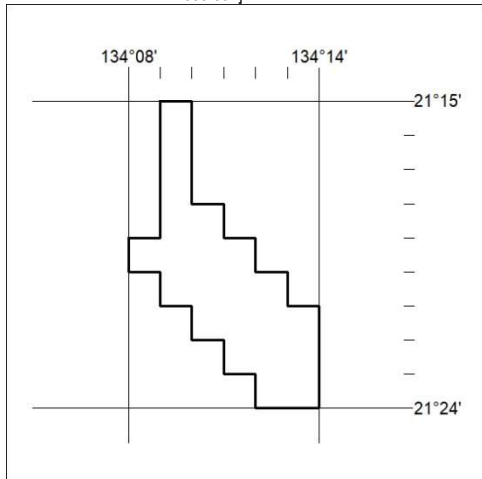

Area granted is indicated above. The titleholder is not permitted to exercise occupational rights on any land that is subject to a development title, or an application for a development title. Any land the subject of a Reserved Land gazettal under the *Mineral Titles Act* and all land vested in the Commonwealth of Australia is also excluded by description but not excised from the grant area.

96/22

MN30/22

DARWIN

6 April 2022

Mineral Titles Act
NOTICE OF GRANT OF A MINERAL TITLE

Title Type and Number: Exploration Licence 32848
Granted: 05 April 2022, for a period of 6 Years
Area: 25 Blocks, 79.95 km²
Locality: CRAWFORD
Name of Holder/s: 100% PEGMATITE ONE PTY LTD [ACN. 652 853 391]

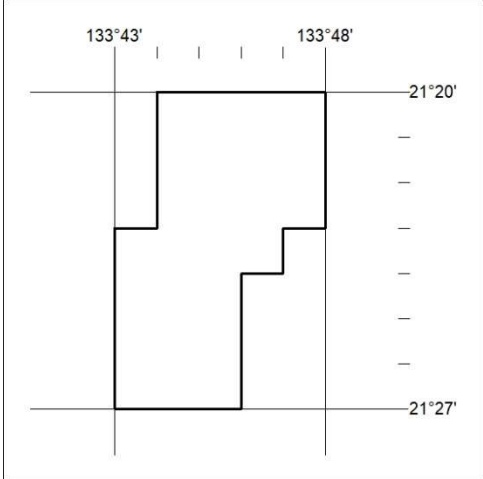

Area granted is indicated above. The titleholder is not permitted to exercise occupational rights on any land that is subject to a development title, or an application for a development title. Any land the subject of a Reserved Land gazettal under the *Mineral Titles Act* and all land vested in the Commonwealth of Australia is also excluded by description but not excised from the grant area.

97/22

Mineral Titles Act
NOTICE OF GRANT OF A MINERAL TITLE

Title Type and Number: Exploration Licence 32852
Granted: 05 April 2022, for a period of 6 Years
Area: 18 Blocks, 57.25 km²
Locality: DENISON
Name of Holder/s: 100% PEGMATITE ONE PTY LTD [ACN. 652 853 391]

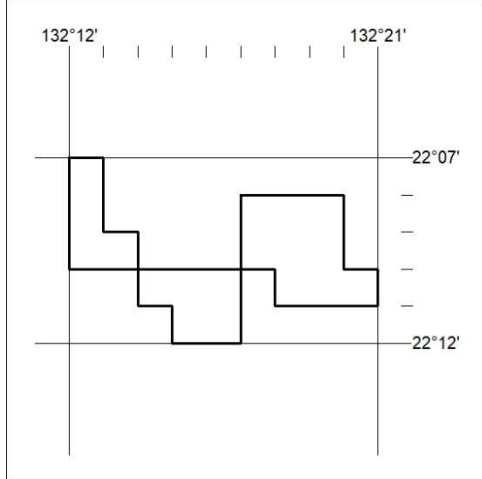

Area granted is indicated above. The titleholder is not permitted to exercise occupational rights on any land that is subject to a development title, or an application for a development title. Any land the subject of a Reserved Land gazettal under the *Mineral Titles Act* and all land vested in the Commonwealth of Australia is also excluded by description but not excised from the grant area.

99/22

Mineral Titles Act
NOTICE OF GRANT OF A MINERAL TITLE

Title Type and Number: Exploration Licence 32851
Granted: 05 April 2022, for a period of 6 Years
Area: 68 Blocks, 216.37 km²
Locality: DENISON
Name of Holder/s: 100% PEGMATITE ONE PTY LTD [ACN. 652 853 391]

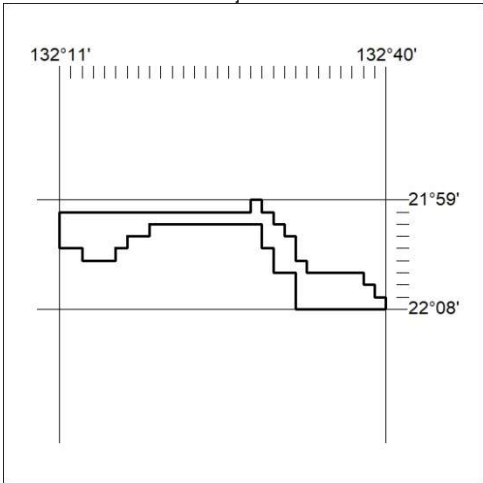

Area granted is indicated above. The titleholder is not permitted to exercise occupational rights on any land that is subject to a development title, or an application for a development title. Any land the subject of a Reserved Land gazettal under the *Mineral Titles Act* and all land vested in the Commonwealth of Australia is also excluded by description but not excised from the grant area.

98/22

Mineral Titles Act
NOTICE OF GRANT OF A MINERAL TITLE

Title Type and Number: Exploration Licence 32853
Granted: 05 April 2022, for a period of 6 Years
Area: 8 Blocks, 25.45 km²
Locality: DENISON
Name of Holder/s: 100% PEGMATITE ONE PTY LTD [ACN. 652 853 391]

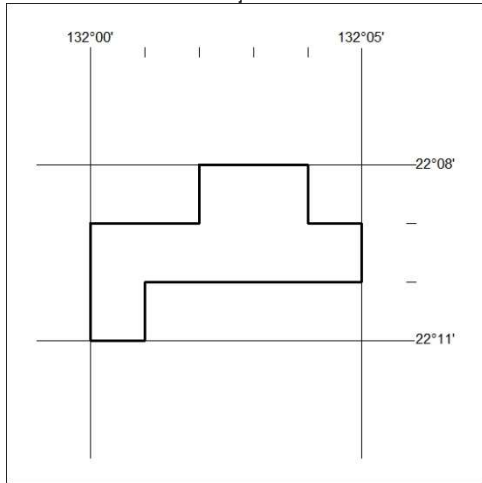

Area granted is indicated above. The titleholder is not permitted to exercise occupational rights on any land that is subject to a development title, or an application for a development title. Any land the subject of a Reserved Land gazettal under the *Mineral Titles Act* and all land vested in the Commonwealth of Australia is also excluded by description but not excised from the grant area.

100/22

MN30/22

DARWIN

6 April 2022

Mineral Titles Act
NOTICE OF GRANT OF A MINERAL TITLE

Title Type and Number: Exploration Licence 32854
Granted: 05 April 2022, for a period of 6 Years
Area: 206 Blocks, 635.97 km²
Locality: LAUGHLEN
Name of Holder/s: 100% PEGMATITE ONE PTY LTD [ACN. 652 853 391]

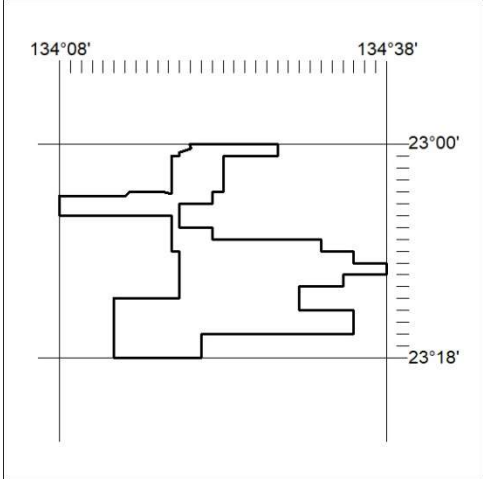

Area granted is indicated above. The titleholder is not permitted to exercise occupational rights on any land that is subject to a development title, or an application for a development title. Any land the subject of a Reserved Land gazettal under the *Mineral Titles Act* and all land vested in the Commonwealth of Australia is also excluded by description but not excised from the grant area.

101/22

Mineral Titles Act
NOTICE OF GRANT OF A MINERAL TITLE

Title Type and Number: Exploration Licence 32861
Granted: 05 April 2022, for a period of 6 Years
Area: 208 Blocks, 660.71 km²
Locality: TEA TREE
Name of Holder/s: 100% PEGMATITE ONE PTY LTD [ACN. 652 853 391]

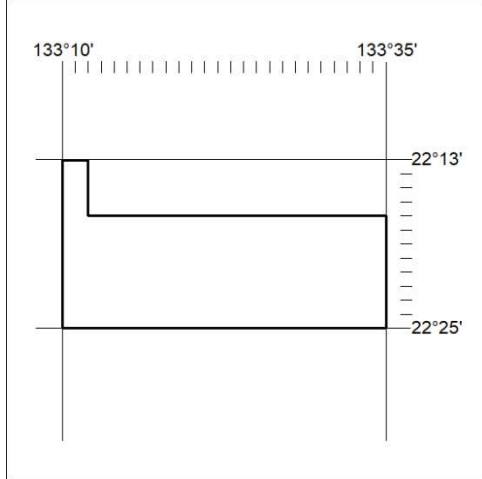

Area granted is indicated above. The titleholder is not permitted to exercise occupational rights on any land that is subject to a development title, or an application for a development title. Any land the subject of a Reserved Land gazettal under the *Mineral Titles Act* and all land vested in the Commonwealth of Australia is also excluded by description but not excised from the grant area.

103/22

Mineral Titles Act
NOTICE OF GRANT OF A MINERAL TITLE

Title Type and Number: Exploration Licence 32855
Granted: 05 April 2022, for a period of 6 Years
Area: 86 Blocks, 271.32 km²
Locality: RIDDOCH
Name of Holder/s: 100% PEGMATITE ONE PTY LTD [ACN. 652 853 391]

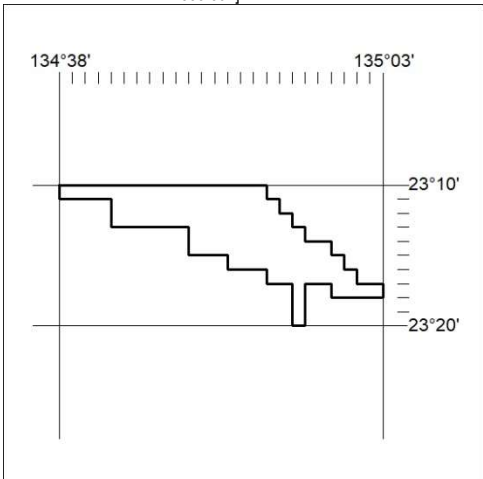

Area granted is indicated above. The titleholder is not permitted to exercise occupational rights on any land that is subject to a development title, or an application for a development title. Any land the subject of a Reserved Land gazettal under the *Mineral Titles Act* and all land vested in the Commonwealth of Australia is also excluded by description but not excised from the grant area.

102/22

Mineral Titles Act
NOTICE OF GRANT OF A MINERAL TITLE

Title Type and Number: Exploration Licence 32862
Granted: 05 April 2022, for a period of 6 Years
Area: 74 Blocks, 234.82 km²
Locality: TEA TREE
Name of Holder/s: 100% PEGMATITE ONE PTY LTD [ACN. 652 853 391]

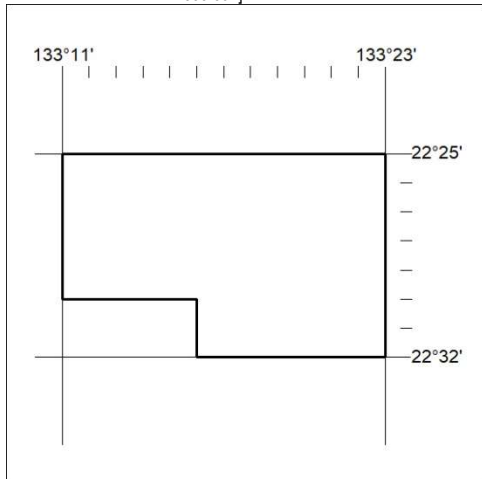

Area granted is indicated above. The titleholder is not permitted to exercise occupational rights on any land that is subject to a development title, or an application for a development title. Any land the subject of a Reserved Land gazettal under the *Mineral Titles Act* and all land vested in the Commonwealth of Australia is also excluded by description but not excised from the grant area.

104/22

MN30/22

DARWIN

6 April 2022

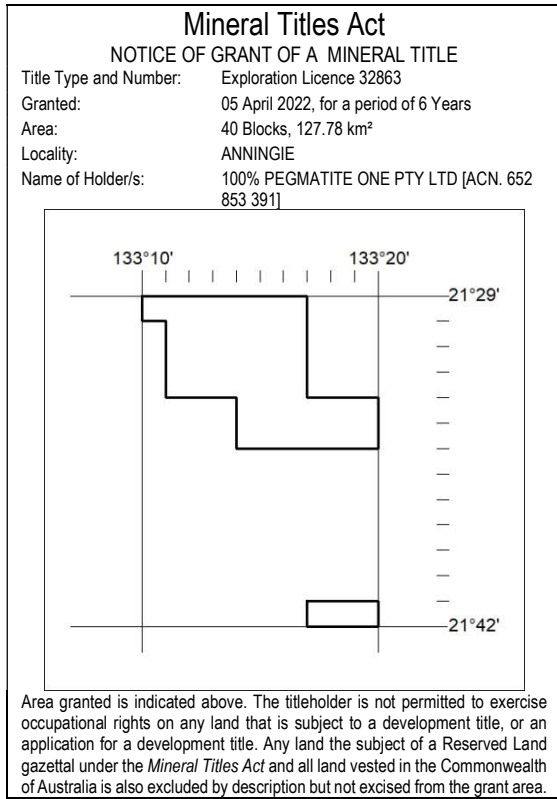

105/22

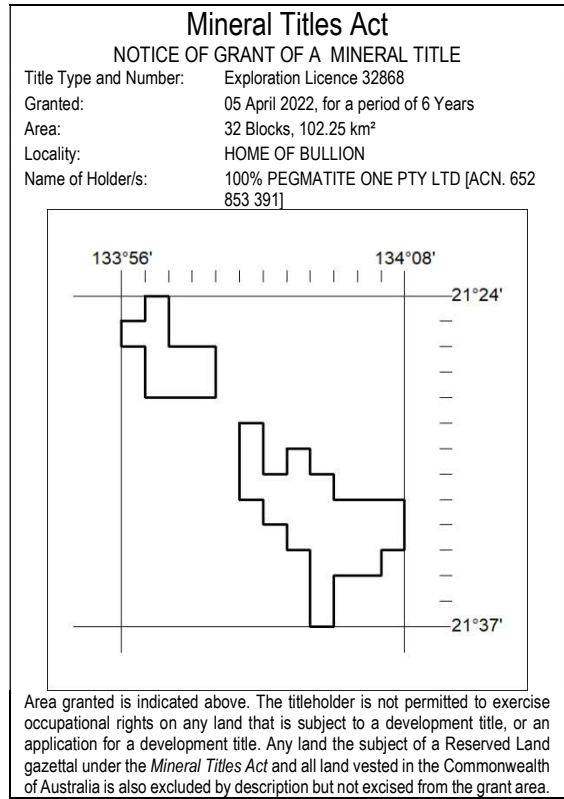

107/22

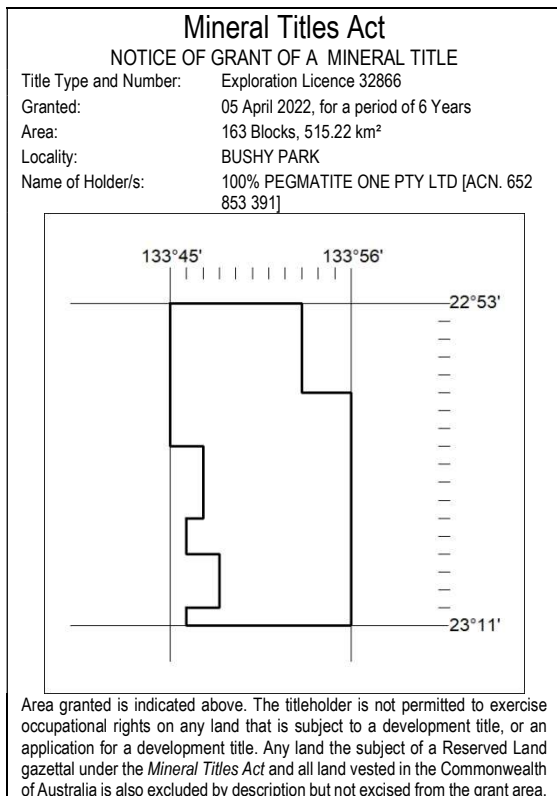

106/22

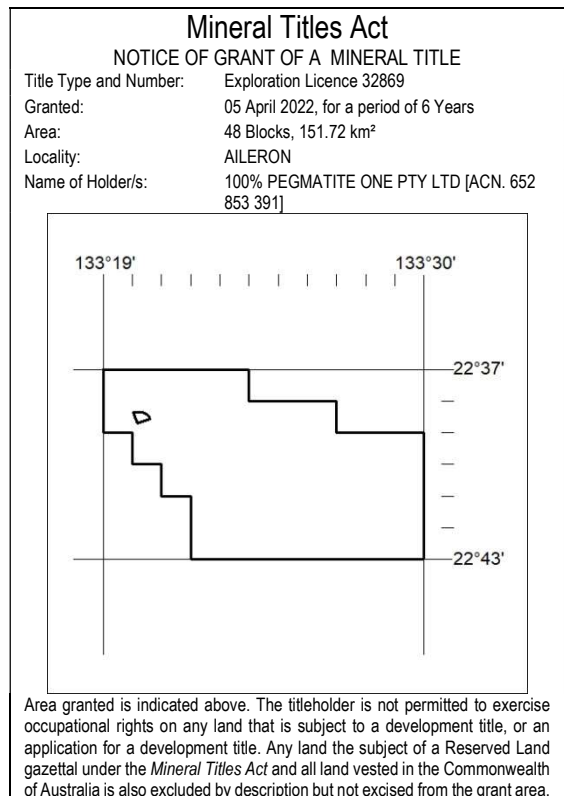

108/22

MN30/22

DARWIN

6 April 2022

Mineral Titles Act
NOTICE OF GRANT OF A MINERAL TITLE

Title Type and Number: Exploration Licence 32871
Granted: 05 April 2022, for a period of 6 Years
Area: 119 Blocks, 377.59 km²
Locality: WOODGREEN
Name of Holder/s: 100% PEGMATITE ONE PTY LTD [ACN. 652 853 391]

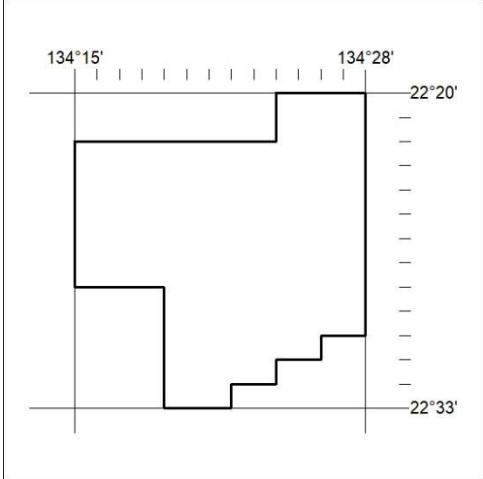

Area granted is indicated above. The titleholder is not permitted to exercise occupational rights on any land that is subject to a development title, or an application for a development title. Any land the subject of a Reserved Land gazettal under the *Mineral Titles Act* and all land vested in the Commonwealth of Australia is also excluded by description but not excised from the grant area.

109/22

Mineral Titles Act
NOTICE OF GRANT OF A MINERAL TITLE

Title Type and Number: Exploration Licence 32872
Granted: 05 April 2022, for a period of 6 Years
Area: 244 Blocks, 762.15 km²
Locality: MACDONALD DOWNS
Name of Holder/s: 100% PEGMATITE ONE PTY LTD [ACN. 652 853 391]

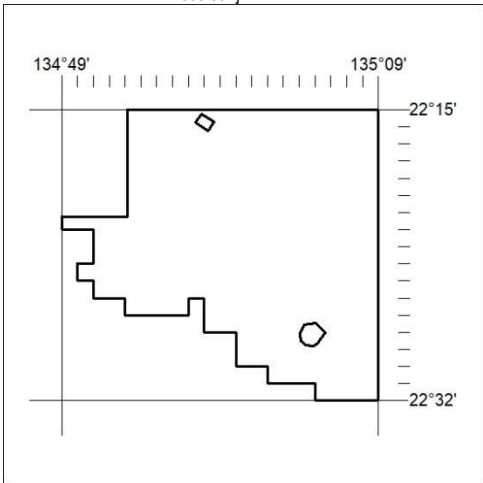

Area granted is indicated above. The titleholder is not permitted to exercise occupational rights on any land that is subject to a development title, or an application for a development title. Any land the subject of a Reserved Land gazettal under the *Mineral Titles Act* and all land vested in the Commonwealth of Australia is also excluded by description but not excised from the grant area.

110/22